

PITUMEC

THE PES 215 ECCENTRIC UNDERREAMING SYSTEM



CASING SIZE 254MM OD X 240MM ID DRILLING DIA. 276MM

PNEUMEC PES 215 ECCENTRIC UNDERREAMING SYSTEM

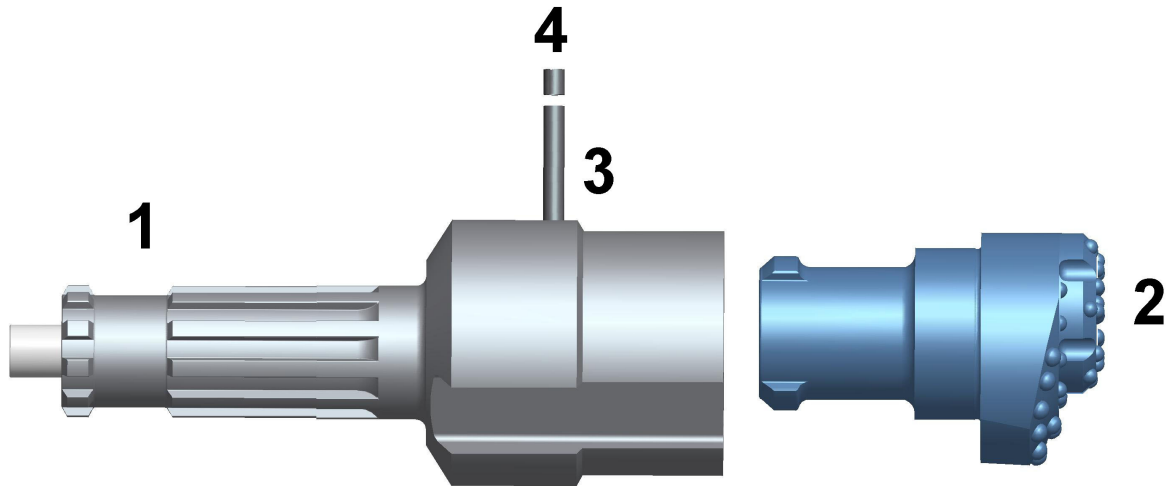

PES 215 PARTS LIST

1.	GUIDE DEVICE DHD380 SHANK	UGD215380PES
2.	ECCENTRIC BIT	UPB215PES
3.	LOCKING PIN	USP21550PES
4.	SPLIT PIN	USP21551PES
5.	COMPLETE SYSTEM	UCS215380PES

PES 215 SPECIFICATIONS

UPPER BODY DIAMETER	236MM	CLOSED DIAMETER	215MM
REAMING DIAMETER	276MM	CASING SIZE	254MM OD X 240MM ID
SYSTEM LENGTH	720MM	SYSTEM WEIGHT	135KG

PES 215 CASING SHOES

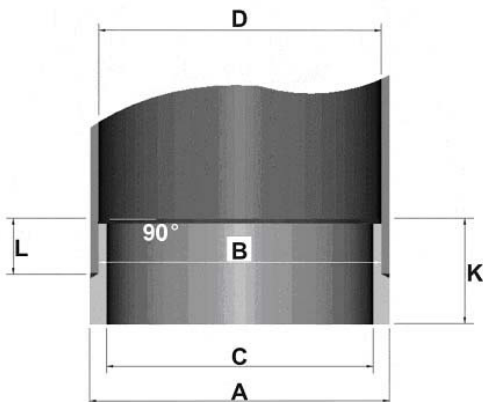

DIA. A	254MM
DIA. B	236MM
DIA. C	218MM
DIA. D	240MM
L	71MM
K	115MM



PNEUMEC COMPANY LIMITED

1st Floor, Tin On Sing Comm. Bldg., 41-43 Graham St. Central, H.K.

Tel : (852) 2180 9922

Fax : (852) 2180 9982

Website : www.pneumec.com

email : info@pneumec.com